

Einbauantenne 2.4 GHz IP54
Spritzwassergeschützt IP54, Best.Nr. 17014.IPEX



mit 6mm-Gewindestutzen und 13cm langem Anschlußkabel mit IPEX (U.FL®)-Stecker. Die Abdichtung des Gewindestutzens im Gehäuse ist vom Kunden sicherzustellen.
Lieferung mit Mutter und Zahnscheibe.

Specifications:

Frequency Range :	2.4 ~ 2.4835GHz
VSWR :	≤ 2.0
Impedance :	50Ω ± 5Ω
Gain :	1dBi
Polarization :	Vertical
Power Handling :	1 Watt
Beam Width :	H: 360° / E: 57°
Connector :	IPEX (others available on request)
Operation Temp. :	-30° ~ +60°
Material :	Radome: ABS Base: ABS
Dimension (L*W*H) :	Ø13*150 mm
Weight :	6g ± 2g
Color :	BLACK

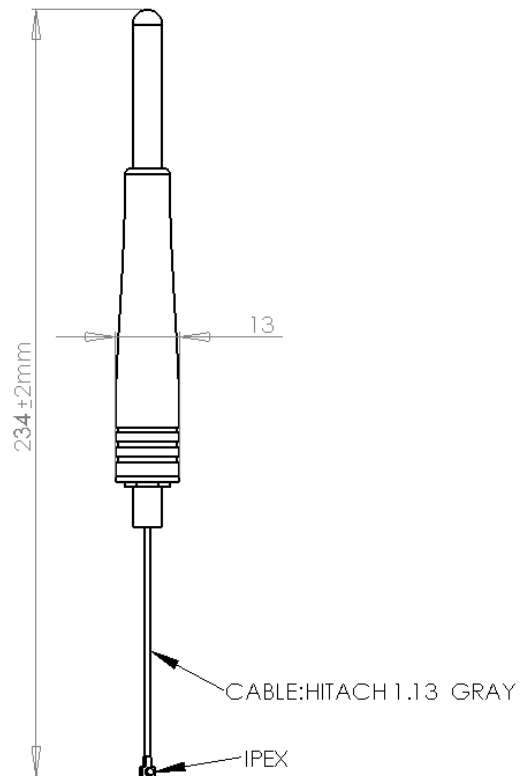

WiMo Antennen und Elektronik GmbH

Am Gäxwald 14, D-76863 Herxheim Tel. (07276) 96680 FAX 9668-11
<http://www.wimo.com> e-mail: info@wimo.com

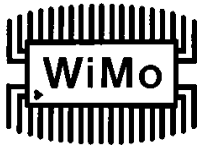

Einbauantenne 2.4 GHz IP54
Spritzwassergeschützt IP54, Best.Nr. 17014.IPEX

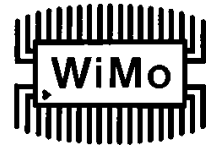

Return Loss

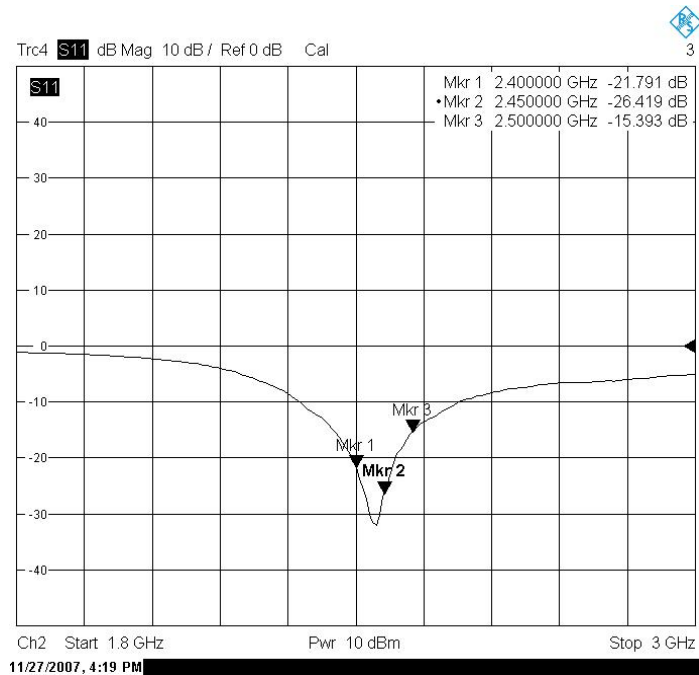

SWR

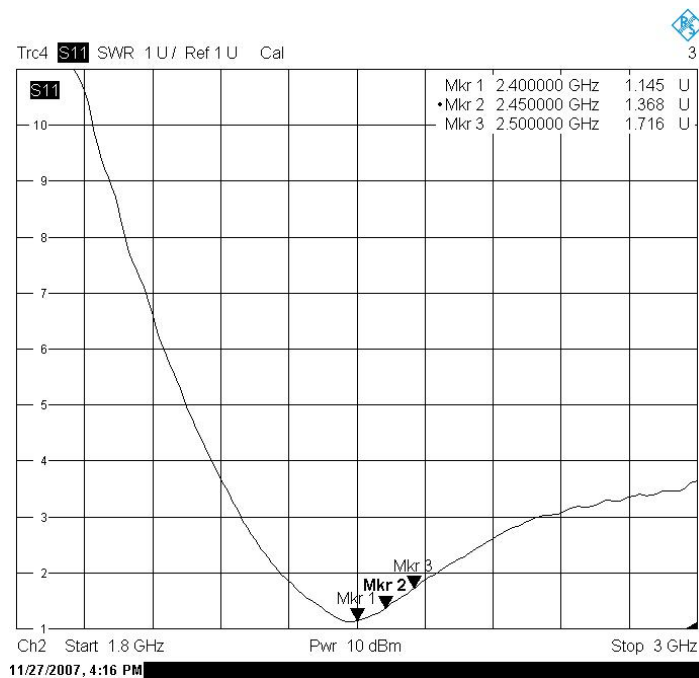

WiMo Antennen und Elektronik GmbH

Am Gäxwald 14, D-76863 Herxheim Tel. (07276) 96680 FAX 9668-11

<http://www.wimo.com>

e-mail: info@wimo.com

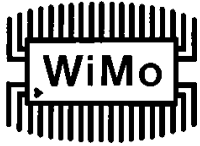

Einbauantenne 2.4 GHz IP54
Spritzwassergeschützt IP54, Best.Nr. 17014.IPEX



H Plane

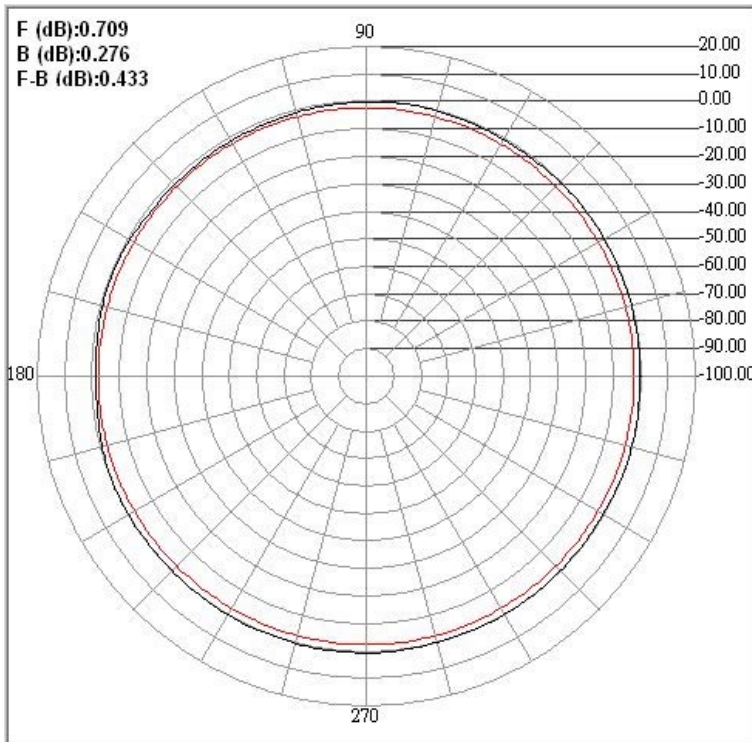

E Plane

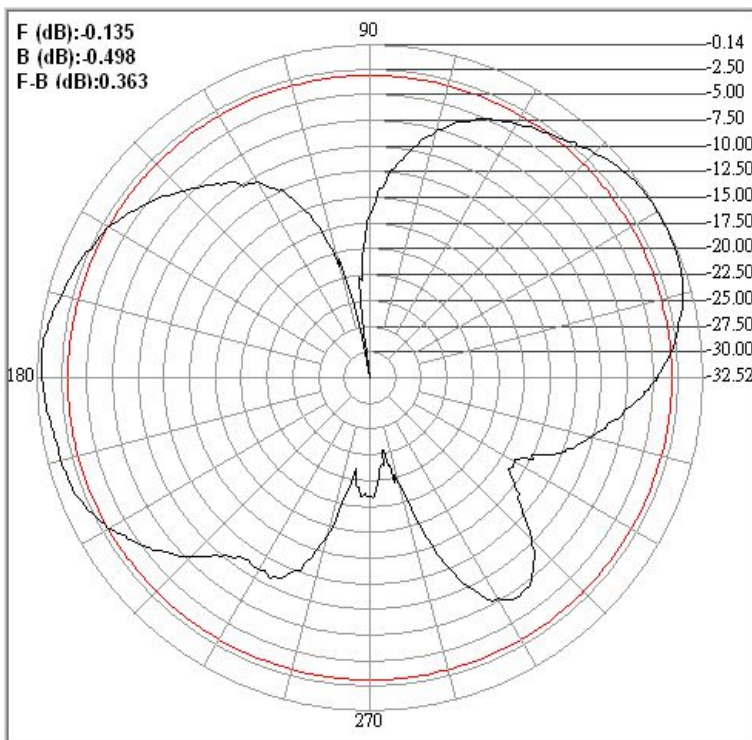

WiMo Antennen und Elektronik GmbH

Am Gäxwald 14, D-76863 Herxheim Tel. (07276) 96680 FAX 9668-11

<http://www.wimo.com>

e-mail: info@wimo.com